

**GUIONNET-JONES-SHLYAKHTENKO SUBFACTORS
ASSOCIATED TO FINITE-DIMENSIONAL KAC ALGEBRAS**

VIJAY KODIYALAM AND V. S. SUNDER

ABSTRACT. We analyse the Guionnet-Jones-Shlyakhtenko construction for the planar algebra associated to a finite-dimensional Kac algebra and identify the factors that arise as finite interpolated free group factors.

The main theorem of [GnnJnsShl2008] constructs an extremal finite index II_1 subfactor $N = M_0 \subseteq M_1 = M$ from a subfactor planar algebra P with the property that the planar algebra of $N \subseteq M$ is isomorphic to P . We show in this paper that if $P = P(H)$ - the (subfactor) planar algebra associated with an n -dimensional Kac algebra H (with $n > 1$) - then, for the associated subfactor $N \subseteq M$, there are isomorphisms $M \cong LF(2\sqrt{n} - 1)$ and $N \cong LF(2n\sqrt{n} - 2n + 1)$, where $LF(r)$ for $r > 1$ is the interpolated free group factor of [Dyk1994] and [Rdl1994].

The first three sections of this paper are devoted to recalling various results we need. In §1 we summarise the Guionnet-Jones-Shlyakhtenko (henceforth GJS) construction. We discuss, in §2, a presentation of the planar algebra associated to a finite-dimensional Kac algebra in terms of generators and relations. The goal of §3 is to collect together results that we use from free probability theory. The longer sections, §4 and §5 are devoted to analysing the structure of the factors M_1 and M_2 respectively. The final §6 proves our main result.

1. GUIONNET-JONES-SHLYAKHTENKO SUBFACTORS

We begin with a quick review of the GJS construction (see also [JnsShlWlk2008] and [KdySnd2008]). All tangles used in the definitions are illustrated in Figure 1.

Suppose that P is a subfactor planar algebra (see [Jns1999] or [KdySnd2004] for detailed definitions) of modulus $\delta > 1$. Construct a tower of graded $*$ -algebras $Gr_k(P)$ for $k \geq 0$ as follows. Set $Gr_k(P) = \bigoplus_{n=k}^{\infty} P_n$ and define multiplication on $Gr_k(P)$ by requiring that if $a \in P_m \subseteq Gr_k(P)$ and $b \in P_n \subseteq Gr_k(P)$, then $a \bullet b \in P_{m+n-k} \subseteq Gr_k(P)$ is given by $a \bullet b = Z_M(a, b)$.

In Figure 1 and other figures in this paper, we use the convention introduced in [KdySnd2008] of decorating strands in a tangle with non-negative integers to represent cablings of that strand. The notation for tangles such as $M = M(k)_{m,n}^{m+n-k}$ in Figure 1 indicates that it is affiliated to $Gr_k(P)$, takes inputs from P_m and P_n and has output in P_{m+n-k} .

The $*$ -structure on $Gr_k(P)$ (denoted by \dagger to distinguish it from the $*$ -structure of the planar algebra P) is defined by letting $a^\dagger \in P_n \subseteq Gr_k(P)$ be given by $a^\dagger = Z_D(a^*)$ for $a \in P_n \subseteq Gr_k(P)$. The inclusion map $Gr_{k-1}(P) \rightarrow Gr_k(P)$ is defined to be the graded map whose restriction to $P_{n-1} \subseteq Gr_{k-1}(P)$ is given by Z_I .

Motivated by free probability theory (but having an entirely planar algebraic definition) is a trace Tr_k defined on $Gr_k(P)$ by letting $Tr_k(a)$ for $a \in P_m \subseteq Gr_k(P)$

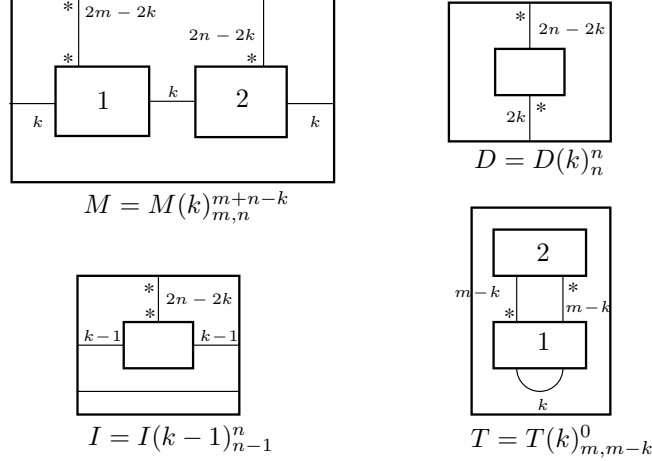
FIGURE 1. Tangles defining structure maps of $Gr_k(P)$.

be given by $Z_T(a \otimes T_{m-k})$ where $T_m \in P_m$ is defined to be the sum of all the Temperley-Lieb elements of P_m . The normalised family $\tau_k = \delta^{-k} Tr_k$ of traces on $Gr_k(P)$ is then consistent with the inclusions.

Theorem 1 (see [GnnJnsShl2008]). *For each $k \geq 0$, the trace τ_k is a faithful, positive trace on $Gr_k(P)$. If M_k denotes the von Neumann algebra generated by $Gr_k(P)$ in the GNS representation afforded by τ_k , there is a tower $M_0 \subseteq M_1 \subseteq M_2 \subseteq \dots$ of II_1 -factors which is the basic construction tower of the extremal subfactor $M_0 \subseteq M_1$ which has index δ^2 and planar algebra isomorphic to P . \square*

2. THE PLANAR ALGEBRA OF A KAC ALGEBRA

In this section we will review (from [KdyLndSnd2003]) the main facts regarding the planar algebra $P(H)$ associated to a finite dimensional Kac algebra H .

For the rest of the paper, fix a Kac algebra (= Hopf C^* -algebra) H of finite dimension $n > 1$. The structure maps of H are denoted by $\mu, \eta, \Delta, \epsilon$ and S . Let H^* be the dual Kac algebra of H and let $\phi \in H^*$ and $h \in H$ denote the normalised traces in the left regular representations of H and H^* respectively. These are central projections that satisfy $ah = \epsilon(a)h$, $\phi\psi = \psi(1)\phi$ for all $a \in H$ and $\psi \in H^*$ and further, $\phi(h) = \frac{1}{n}$.

Let $\delta = \sqrt{n}$. Associated to H is a planar algebra $P = P(H)$ and defined to be the quotient of the universal planar algebra on the labelling set $L = L_2 = H$ by the set of relations in Figure 2 where, (i) we write the relations as identities - so the statement $a = b$ is interpreted as $a - b$ is a relation; (ii) $\zeta \in \mathbb{C}$ and $a, b \in H$; and (iii) the external boxes of all tangles appearing in the relations are left undrawn and it is assumed that all external $*$'s are at the top left corners.

Theorem 2 (Theorem 5.1 of [KdyLndSnd2003]). *The planar algebra $P(H)$ is a subfactor planar algebra of modulus $\delta = \sqrt{n}$ and is the planar algebra of the subfactor $M^H \subseteq M$ where M is the hyperfinite II_1 -factor equipped with an outer action of H . There is a natural identification of H with P_2 under which the antipode S of H corresponds to the action Z_R of the 2-rotation tangle $R = R_2^2$. \square*

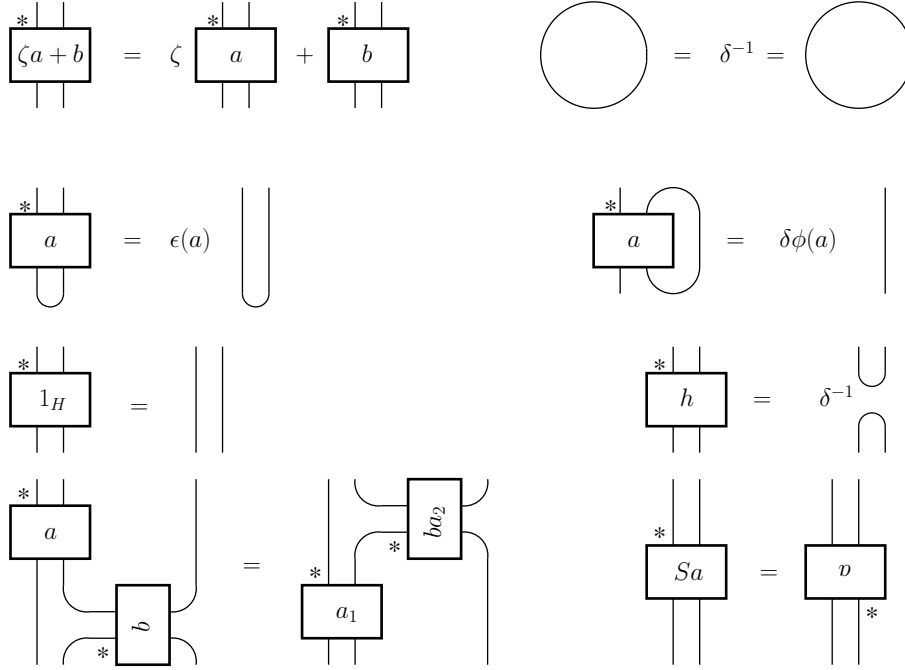
 FIGURE 2. Relations in $P(H)$

We pause to remark that the convention regarding the labelling of boxes in multiplication tangles in this paper agrees with that of [GnnJnsShl2008] and of [KdySnd2008] but is opposite to that of [KdyLndSnd2003] and so one of the relations here appears to be different from the corresponding one in [KdyLndSnd2003].

We will have occasion to use some other facts about $P(H)$ that depend on an explicit choice of basis for H . Suppose that \widehat{H}^* is a complete set of inequivalent irreducible $*$ -representations of H^* ; we will denote a typical element of \widehat{H}^* by γ and its dimension by d_γ . Then the set $\{\gamma_{pq} \in H : \gamma \in \widehat{H}^*, 1 \leq p, q \leq d_\gamma\}$ is a linear basis for H .

- Proposition 3.** (1) Let $\gamma \in \widehat{H}^*$. Then, $\gamma_{pq}^* = S\gamma_{qp}$.
- (2) The set $\{\widetilde{\gamma}_{pq} = \sqrt{d_\gamma}\gamma_{pq} : \gamma \in \widehat{H}^*, 1 \leq p, q \leq d_\gamma\}$ is an orthonormal basis of H for the inner product defined by ϕ .
- (3) Let $X = X_{2,2,\dots,2}^n$, $n \geq 2$ be the tangle illustrated in Figure 3. A basis of P_n is given by the set $\{Z_X(\gamma_{p_1 q_1}^1, \dots, \gamma_{p_{n-1} q_{n-1}}^{n-1}) : \gamma^i \in \widehat{H}^*, 1 \leq p_i, q_i \leq d_{\gamma^i}\}$. In particular, Z_X is an isomorphism.
- (4) The relation in Figure 4 holds in $P(H)$ for any $\gamma \in \widehat{H}^*$. \square

3. RESULTS FROM FREE PROBABILITY THEORY

The goal of this section is to give a very brief survey of free probability theory and state the results that we will use in later sections. We will use [NcaSpc2006] and [VclDykNca1992] as references.

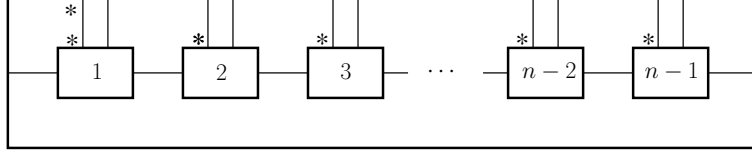
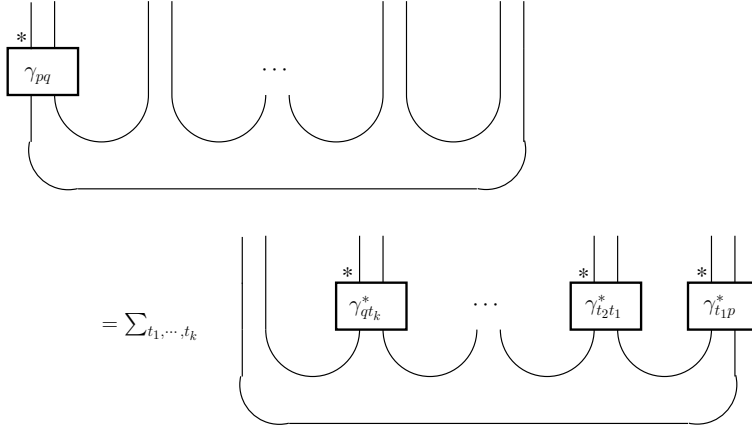
FIGURE 3. The tangle $X = X_{2,2,\dots,2}^n$ FIGURE 4. Useful relation in $P(H)$

Definition 4. An algebraic non-commutative probability space consists of a unital algebra A together with a linear functional ϕ on A such that $\phi(1) = 1$. It is said to be a C^* -algebraic probability space if A is a C^* -algebra and ϕ is a state, and to be a von Neumann algebraic probability space if A is a von Neumann algebra and ϕ is a normal state.

In this paper, all probability spaces we consider have tracial ϕ .

Definition 5. If (A, ϕ) is a non-commutative probability space, a family $\{A_i : i \in I\}$ of unital subalgebras of A is said to be freely independent, or simply free, if for any positive integer k , indices $i_1, i_2, \dots, i_k \in I$ such that $i_1 \neq i_2, i_2 \neq i_3, \dots, i_{k-1} \neq i_k$ and elements $a_t \in A_{i_t}$ with $\phi(a_t) = 0$ for $t = 1, 2, \dots, k$, the equality $\phi(a_1 a_2 \dots a_k) = 0$ holds.

In short, an alternating product of centered elements is to be centered, with the obvious definitions.

Definition 6. If $\{(A_i, \phi_i) : i \in I\}$ is a family of algebraic non-commutative probability spaces, there is a unique linear functional ϕ on the algebraic free product algebra $A = \ast_{i \in I} A_i$, such that $\phi|_{A_i} = \phi_i$ and such that $\{A_i : i \in I\}$ (identified with their images in A) is a freely independent family. The space (A, ϕ) is said to be the free product of the family $\{(A_i, \phi_i) : i \in I\}$.

There are notions of free products of C^* -algebraic and von Neumann algebraic non-commutative probability spaces which require more work to define carefully and which we will use without further explanation - see Chapter 1 of [VclDykNca1992].

In many contexts, it is important to decide whether a given family of subalgebras of a non-commutative probability space is a free family. For our purposes, the most convenient way to do this is in terms of the free cumulants of the space which we will now recall.

The lattice of non-crossing partitions plays a fundamental role in the definition of free cumulants. Recall that for a totally ordered finite set S , a partition π of S is said to be non-crossing if whenever $i < j$ belong to a class of π and $k < l$ belong to a different class of π , then it is not the case that $k < i < l < j$ or $i < k < j < l$. The collection of non-crossing partitions of S , denoted $NC(S)$, forms a lattice for the partial order defined by $\pi \geq \rho$ if π is coarser than ρ or equivalently, if ρ refines π . The largest element of the lattice $NC(S)$ is denoted 1_S . Explicitly, $1_S = \{S\}$. If $S = [n] \stackrel{\text{def}}{=} \{1, 2, \dots, n\}$ for some $n \in \mathbb{N}$, we will write $NC(n)$ and 1_n for $NC(S)$ and 1_S respectively.

If X is any set and $\{\phi_n : X^n \rightarrow \mathbb{C}\}_{n \in \mathbb{N}}$ is a collection of functions, by the multiplicative extension of this collection, we will mean the collection of functions $\{\phi_\pi : X^n \rightarrow \mathbb{C}\}_{n \in \mathbb{N}, \pi \in NC(n)}$ defined by $\phi_\pi(x^1, x^2, \dots, x^n) = \prod_{C \in \pi} \phi_{|C|}(x^c : c \in C)$, where the arguments of each $\phi_{|C|}$ are listed with increasing indices. Note that $\phi_n = \phi_{1_n}$. We now state a basic combinatorial result (roughly equivalent to Proposition 10.21 of [NcaSpc2006]) that we will refer to as Möbius inversion. Let $\mu(\cdot, \cdot)$ be the Möbius function of the lattice $NC(n)$ - see Lecture 10 of [NcaSpc2006].

Theorem 7. *Given two collections of functions $\{\phi_n : X^n \rightarrow \mathbb{C}\}_{n \in \mathbb{N}}$ and $\{\kappa_n : X^n \rightarrow \mathbb{C}\}_{n \in \mathbb{N}}$ extended multiplicatively, the following conditions are all equivalent:*

- (1) $\phi_n = \sum_{\pi \in NC(n)} \kappa_\pi$ for each $n \in \mathbb{N}$.
- (2) $\kappa_n = \sum_{\pi \in NC(n)} \mu(\pi, 1_n) \phi_\pi$ for each $n \in \mathbb{N}$.
- (3) $\phi_\tau = \sum_{\pi \in NC(n), \pi \leq \tau} \kappa_\pi$ for each $n \in \mathbb{N}, \tau \in NC(n)$.
- (4) $\kappa_\tau = \sum_{\pi \in NC(n), \pi \leq \tau} \mu(\pi, \tau) \phi_\pi$ for each $n \in \mathbb{N}, \tau \in NC(n)$.

Sketch of Proof. Clearly (3) \Rightarrow (1) and (4) \Rightarrow (2) by taking $\tau = 1_n$. On the other hand, given (2) and an arbitrary $\tau \in NC(n)$, we get:

$$\begin{aligned} \kappa_\tau(x^1, x^2, \dots, x^n) &= \prod_{C \in \tau} \kappa_{|C|}(x^c : c \in C) \\ &= \prod_{C \in \tau} \sum_{\pi_C \in NC(C)} \mu(\pi_C, 1_C) \phi_{\pi_C}(x^c : c \in C) \\ &= \sum_{\pi \in NC(n), \pi \leq \tau} \mu(\pi, 1_n) \phi_\pi(x^1, x^2, \dots, x^n), \end{aligned}$$

where the last equality is a consequence of the natural bijection between $\{\pi \in NC(n) : \pi \leq \tau\}$ and collections $\{\{\pi_C \in NC(C)\}_{C \in \tau}\}$ given by $\pi = \cup_{C \in \tau} \pi_C$ under which (i) $\phi_\pi(x^1, x^2, \dots, x^n) = \prod_{C \in \tau} \phi_{\pi_C}(x^c : c \in C)$ and (ii) $\mu(\pi, 1_n) = \prod_{C \in \tau} \mu(\pi_C, 1_C)$. This proves (4) and so (2) \Leftrightarrow (4). An even easier proof shows that (1) \Leftrightarrow (3). Finally, (3) \Leftrightarrow (4) by usual Möbius inversion in the poset $NC(n)$. \square

Definition 8. The free cumulants of a non-commutative probability space (A, ϕ) are the functions $\kappa_n : A^n \rightarrow \mathbb{C}$ associated as in Theorem 7 to the collection of functions $\{\phi_n : A^n \rightarrow \mathbb{C}\}_{n \in \mathbb{N}}$ defined by $\phi_n(a^1, \dots, a^n) = \phi(a^1 a^2 \dots a^n)$.

The reason for their importance lies in the following theorem of Speicher.

Theorem 9 (Theorem 11.20 of [NcaSpc2006]). *Let (A, ϕ) be a non-commutative probability space and $\{A_i : i \in I\}$ be a family of unital subalgebras of A such that A_i is generated as an algebra by $G_i \subseteq A_i$. This family is freely independent iff for each positive integer k , indices $i_1, \dots, i_k \in I$ that are not all equal and elements $a_t \in G_{i_t}$ for $t = 1, 2, \dots, k$, the equality $\kappa_k(a_1, a_2, \dots, a_k) = 0$ holds. \square*

We also need a result of Nica and Speicher on ‘ R -cyclic matrices’ - see Lecture 20 of [NcaSpc2006] - of a special type. Let (A, ϕ) be a non-commutative probability space, $d \in \mathbb{N}$ and $(M_d(A), \phi^d)$ be the associated matrix probability space where $\phi^d(X) = \frac{1}{d} \sum_i \phi(x_{ii})$ for $X = ((x_{ij})) \in M_d(A)$. Let $\kappa_*(\dots)$ and $\kappa_*^d(\dots)$ denote the free cumulants of A and $M_d(A)$ respectively.

Definition 10. Call a matrix $X = ((x_{ij})) \in M_d(A)$ uniformly R -cyclic with determining sequence $\{\alpha_t \in \mathbb{C}\}_{t \in \mathbb{N}}$ if for any $i_1, j_1, i_2, j_2, \dots, i_t, j_t \in \{1, 2, \dots, d\}$,

$$\kappa_t(x_{i_1, j_1}, x_{i_2, j_2}, \dots, x_{i_t, j_t}) = \begin{cases} \alpha_t & \text{if } j_1 = i_2, j_2 = i_3, \dots, j_{t-1} = i_t, j_t = i_1 \\ 0 & \text{otherwise} \end{cases}.$$

The adjective ‘uniform’ refers to the fact that the cumulants are independent of the indices i_s, j_s .

Theorem 11 (Theorems 14.18 and 14.20 of [NcaSpc2006]). *Fix $X = ((x_{ij})) \in M_d(A)$. Let $A_1 = M_d(\mathbb{C}) \subseteq M_d(A)$ and A_2 be the unital subalgebra of $M_d(A)$ generated by X . The following conditions are then equivalent:*

- *The matrix X is uniformly R -cyclic with (some) determining sequence $\{\alpha_t\}_{t \in \mathbb{N}}$.*
- *A_1 and A_2 are free.*

If these conditions hold, then $\kappa_t^d(X, X, \dots, X) = d^{t-1} \alpha_t$. \square

The results summarised so far have an algebraic/combinatorial flavour. To get results about subfactors, we need some analytic input that is contained in the next few results. We use the following notation and conventions. If (A, ϕ_A) and (B, ϕ_B) are non-commutative probability spaces and $0 < \alpha < 1$, by $A \oplus_{\alpha, 1-\alpha} B$, we will denote the non-commutative probability space $(A \oplus B, \phi)$ where $\phi = \alpha \phi_A + (1 - \alpha) \phi_B$. If $\alpha = 0$ (respectively $\alpha = 1$) then $A \oplus_{\alpha, 1-\alpha} B$ will denote (B, ϕ_B) (respectively (A, ϕ_A)). If $A = LG$ is the von Neumann algebra of a countable group G , then we will regard A as a von Neumann algebraic tracial probability space with ϕ_A determined by $\phi_A(g) = \delta_{g1}$ for $g \in G$. If A is a finite factor, we regard A as a von Neumann algebraic probability space with $\phi_A = \text{tr}_A$ - the unique trace on A .

Lemma 12 (Proposition 2.5.7 of [VclDykNca1992]). *Let (A, ϕ) be a von Neumann algebraic non-commutative probability space and $\{A_i : i \in I\}$ be a family of unital $*$ -subalgebras of A . Then $\{A_i : i \in I\}$ is a free family iff $\{A_i'' : i \in I\}$ is a free family. \square*

Proposition 13. *Let (A, ϕ) be a von Neumann algebraic non-commutative probability space with free cumulants κ_n and let $x \in A$ be a self-adjoint element such that $\kappa_n(x, x, \dots, x) = \delta^{n-1}$ for a $\delta > 1$. Let B be the von Neumann algebra generated by x and set $\phi_B = \phi|_B$. Then*

$$(B, \phi_B) \cong \mathbb{C} \oplus_{1-\delta^{-1}, \delta^{-1}} LZ.$$

Proof. Recall that a self-adjoint element a in a von Neumann algebraic probability space is said to be a free Poisson variable with rate $\lambda > 0$ and jump size $\alpha \in \mathbb{R}$ if $\kappa_t(a, a, \dots, a) = \lambda \alpha^t$. Thus our element x is free Poisson with rate δ^{-1} and jump-size δ and, by Proposition 12.11 of [NcaSpc2006], generates a von Neumann algebra isomorphic to $L^\infty(\mathbb{R}, \mu)$ where the measure μ is of the form $(1 - \delta^{-1})\nu_0 + \delta^{-1}\nu$ - where ν_0 is the point-mass at 0 and ν is a probability measure supported on an interval $[a, b] \subseteq (0, \infty)$ that is mutually absolutely continuous with respect to the Lebesgue measure. Under this isomorphism, ϕ_B goes over to integration with respect to μ .

Hence

$$\begin{aligned} (B, \phi|_B) &\cong (L^\infty(\{0\}, \nu_0), \int_{1-\delta^{-1}}(\cdot)d\nu_0) \oplus ((L^\infty([a, b], \nu), \int_{\delta^{-1}}(\cdot)d\nu) \\ &\cong (\mathbb{C}, id_{\mathbb{C}})_{1-\delta^{-1}} \oplus ((L^\infty(S^1, m), \int_{\delta^{-1}}(\cdot)dm) \\ &\cong \mathbb{C}_{1-\delta^{-1}} \oplus LZ_{\delta^{-1}}, \end{aligned}$$

where the last isomorphism uses the Fourier transform. \square

Thus, Proposition 13 determines the von Neumann algebraic probability space generated by a free Poisson variable with rate δ^{-1} and jump size δ .

We now recall from [Dyk1994] and [Rdl1994] basic properties of the interpolated free group factors $LF(r)$ defined for $r > 1$. Set $LF(1) = LZ$. If M is a finite factor and $\alpha > 0$, the α -ampliation of M (defined only for α being an integral multiple of $\frac{1}{n}$ if M is of type I_n) denoted M_α , - see [MrrNmn1943] - stands for pMp where $p \in M$ is a projection of trace α if $\alpha < 1$, for $M_n(M)$ if $\alpha = n \in \mathbb{N}$, and satisfies $(M_\alpha)_\beta \cong M_{\alpha\beta}$ in general.

Proposition 14 (Theorems 4.1 and 2.4 of [Dyk1994], Propositions 4.4 and 4.5 of [Rdl1994]). *Let $r, s > 1$ and $\alpha > 0$. Then:*

- (1) $LF(r) * LF(s) \cong LF(r + s)$, and
- (2) $LF(r)_\alpha \cong LF(\frac{r-1}{\alpha^2} + 1)$. \square

The other analytic results we need are from [Dyk1994] on computations of free products of tracial von Neumann algebraic probability spaces.

Proposition 15 (Proposition 1.7 of [Dyk1994]). *Let $r, s \geq 1$ and $0 \leq \alpha, \beta \leq 1$. Then:*

$$\begin{aligned} (\mathbb{C}_{1-\alpha} \oplus LF(r)_\alpha) * (\mathbb{C}_{1-\beta} \oplus LF(s)_\beta) = \\ \begin{cases} LF(r\alpha^2 + 2\alpha(1-\alpha) + s\beta^2 + 2\beta(1-\beta)) & \text{if } \alpha + \beta \geq 1 \\ \mathbb{C}_{1-\alpha-\beta} \oplus LF(\underbrace{(\alpha + \beta)^{-2}(r\alpha^2 + s\beta^2 + 4\alpha\beta)}_{\alpha+\beta}) & \text{if } \alpha + \beta \leq 1. \end{cases} \quad \square \end{aligned}$$

What we will actually use is the following corollary of Proposition 15 which is easily proved by induction on N .

Corollary 16. *Let $\delta > 1$ and $N \in \mathbb{N}$. Then*

$$\left(\mathbb{C}_{1-\delta^{-1}} \oplus LZ_{\delta^{-1}} \right)^{*N} = \begin{cases} LF(N(2\delta^{-1} - \delta^{-2})) & \text{if } N \geq \delta \\ \mathbb{C}_{1-N\delta^{-1}} \oplus LF(2 - \frac{1}{N})_{N\delta^{-1}} & \text{if } N \leq \delta. \end{cases} \quad \square$$

Proposition 17 (Lemma 3.4 of [Dyk1994]). *Let $r \geq 1$ and $0 \leq \alpha \leq 1$ and $d \in \mathbb{N}$. Then:*

$$\left(\begin{array}{c} \mathbb{C} \\ 1-\alpha \end{array} \oplus \begin{array}{c} LF(r) \\ \alpha \end{array} \right) * M_d(\mathbb{C}) = \begin{cases} LF(r\alpha^2 + 2\alpha(1-\alpha) + 1 - d^{-2}) & \text{if } \alpha \geq d^{-2} \\ M_d(\mathbb{C}) \oplus LF(rd^{-4} - 2d^{-4} + 1 + d^{-2}) & \text{if } \alpha \leq d^{-2}. \end{cases} \quad \square$$

Proposition 18 (Special case of Theorem 4.6 of [Dyk1994]). *Let A be a finite-dimensional von Neumann algebra and ϕ be the normalised trace on A in its left regular representation (so that each central minimal projection of A has trace $\frac{1}{n}$). Suppose that $\frac{1}{n} \leq \alpha \leq 1$. Then,*

$$\left(\begin{array}{c} \mathbb{C} \\ 1-\alpha \end{array} \oplus \begin{array}{c} LZ \\ \alpha \end{array} \right) * A \cong LF\left(2\alpha - \alpha^2 + 1 - \frac{1}{n}\right). \quad \square$$

4. DETERMINATION OF M_1

Let H be a finite dimensional Kac algebra of dimension $n > 1$ and let $P = P(H)$ be its planar algebra. Let $M_0 \subseteq M_1 \subseteq \dots$ be the tower of factors associated to P by the GJS-construction, so that M_k is the von Neumann algebra generated by $Gr_k(P)$ in the GNS-representation afforded by τ_k . Our goal in this section is to prove the following theorem.

Theorem 19. *Let H be a finite dimensional Kac algebra of dimension $n > 1$, $P = P(H)$ be its planar algebra and $M_0 \subseteq M_1 \subseteq \dots$ be the tower of factors associated with P by the GJS-construction. Then, $M_1 \cong LF(2\sqrt{n} - 1)$.*

The strategy of proof is to find a free family $\{A(\gamma)\}_\gamma$ of subalgebras of $Gr_1(P)$ that generate it as an algebra (and hence also M_1 as a von Neumann algebra), identify the von Neumann algebra $M(\gamma) = A(\gamma)''$, and compute $*_\gamma M(\gamma)$, which is M_1 . To begin with, we determine the structure of $Gr_1(P)$.

Let $T(H) = \bigoplus_{n \geq 0} H^{\otimes n}$ be the tensor algebra of the complex vector space H regarded as a graded algebra with $H^{\otimes n}$ being the degree n piece. Define a $*$ -structure on $T(H)$ by defining $(x^1 \otimes x^2 \otimes \dots \otimes x^n)^* = S(x^n)^* \otimes \dots \otimes S(x^2)^* \otimes S(x^1)^*$, for $x^1, x^2, \dots, x^n \in H$. Recall that S is the antipode of H and corresponds - see Theorem 2 - to the rotation map Z_R on P_2 (under the identification of H with P_2).

Proposition 20. *As graded $*$ -algebras, $T(H)$ and $Gr_1(P)$ are isomorphic.*

Proof. Define a graded map from $T(H)$ to $Gr_1(P)$ by letting its restriction to $H^{\otimes(n-1)} \subseteq T(H)$ be Z_X where $X = X_{2,2,\dots,2}^n$ as defined in Figure 3. This map is easily verified to be a $*$ -algebra isomorphism. Indeed, multiplicativity amounts to checking that with $M = M(1)_{m,n}^{m+n-1}$, $M \circ_{(1,2)} (X_{2,2,\dots,2}^m, X_{2,2,\dots,2}^n) = X_{2,2,\dots,2}^{m+n-1}$, while $*$ -preservation is seen to follow from $D \circ X^* = \sigma(X) \circ_{(1,2,\dots,n-1)} (R, R, \dots, R)$ where, $D = D(1)_n^n$, $X = X_{2,2,\dots,2}^n$, σ is the order reversing involution of $\{1, 2, \dots, n-1\}$ and $\sigma(X)$ is the tangle X with i^{th} -internal box numbered $\sigma(i)$ for each i . Both these tangle facts are seen to hold by drawing the appropriate pictures.

Finally, it is seen from Proposition 3(3) that this map yields an isomorphism, as desired. \square

Note that Proposition 20 implies that $Gr_1(P)$ is generated as a unital algebra by $P_2 \subseteq Gr_1(P)$. We now regard $Gr_1(P)$ together with its trace $\tau_1 = \delta^{-1}Tr_1$ as a non-commutative probability space. Denoting the free cumulants by $\kappa_*(\dots)$, we wish to compute these explicitly on the generators. This can be done in greater generality as in Proposition 21.

Proposition 21. *Let P be any subfactor planar algebra of modulus δ that is irreducible (i.e., $P_1 \cong \mathbb{C}$), and $(Gr_1(P), \tau_1)$ be the GJS-probability space associated to it (as in the preceding paragraph). If $x^1, \dots, x^t \in P_2 \subseteq Gr_1(P)$, then $\kappa_t(x^1, x^2, \dots, x^t)$ is given by the tangle in Figure 5.*

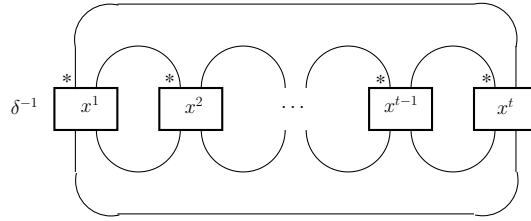

FIGURE 5. Identification of the free cumulants

Before proving this, we remind the reader of the well-known bijection between non-crossing partitions and Temperley-Lieb diagrams. We illustrate this in Figure 6 with a single example that should suffice. The Temperley-Lieb diagram

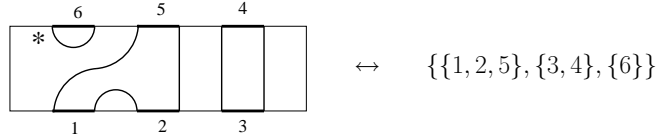

FIGURE 6. Bijection between TL-diagrams and non-crossing partitions

on the left is to correspond to the non-crossing partition on the right. Given a Temperley-Lieb diagram T , number the black boundary segments of the diagram anti-clockwise and take the partition corresponding to the black regions to get the associated non-crossing partition π_T . In the reverse direction, denote the TL-diagram corresponding to a non-crossing partition π by $TL(\pi)$ so that, for instance, $T_k = \sum_{\pi \in NC(k)} TL(\pi)$, where, T_k (recall from §1) is the sum of all the Temperley-Lieb elements of P_k .

Proof of Proposition 21. By definition of the product and trace in $Gr_1(P)$, we see that $\tau_1(x^1 x^2 \dots x^t)$ is given by the expression in Figure 7.

We analyse the π -term of this sum. Since any non-crossing partition has a class that is an interval, let C be such a class of π and suppose that $C = [k, l]$ where $1 \leq k \leq l \leq t$. The π -term then contains as a ‘sub-picture’ the 1-tangle in Figure 8. The irreducibility of the planar algebra P implies that this 1-tangle is a scalar multiple of 1_1 (the unit element of P_1) the scalar being given in Figure 9.

We may now peel off the next class of π that is an interval and proceed by induction to conclude that $\tau_1(x^1 x^2 \dots x^t)$ is given by the expression in Figure 10,

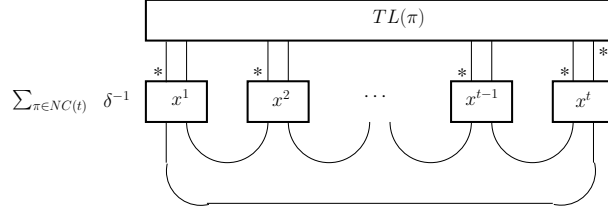

FIGURE 7. The trace of a product of elements of $P_2 \subseteq Gr_1(P)$

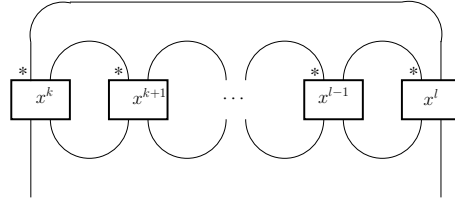

FIGURE 8. Sub-picture corresponding to the class C of π

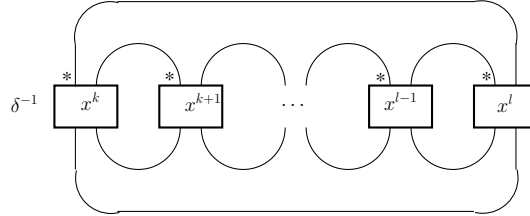

FIGURE 9.

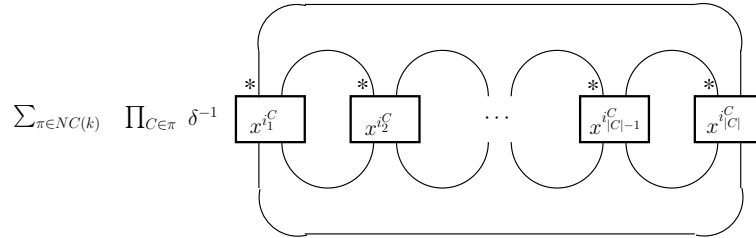

FIGURE 10. Expression for $\tau_1(x^1 x^2 \cdots x^t)$

where we write $C = \{i_1^C, i_2^C, \dots, i_{|C|}^C\}$. Now, Mobius inversion (the implication (1) \Rightarrow (2) of Theorem 7) yields the desired expression for $\kappa_t(x^1, x^2, \dots, x^t)$. \square

We extract a corollary of Proposition 21 when $P = P(H)$. For $\gamma \in \widehat{H}^*$, let $A(\gamma)$ denote the subalgebra of $Gr_1(P)$ generated by $\gamma_{kl} \in P_2 \subseteq Gr_1(P)$ for $1 \leq k, l \leq d_\gamma$

and let $M(\gamma) = A(\gamma)'' \subseteq M_1$. Let $X(\gamma) \in M_{d_\gamma}(M_1)$ be the $d_\gamma \times d_\gamma$ matrix $X(\gamma) = ((\gamma_{kl}))$, and $\kappa_*^{d_\gamma}(\dots)$ denote the free cumulants of $M_{d_\gamma}(M_1)$.

Corollary 22. (1) For each $\gamma \in \widehat{H}^*$, the matrix $X(\gamma)$ is uniformly R -cyclic with determining sequence $\{(\frac{\delta}{d_\gamma})^{t-1}\}_{t \in \mathbb{N}}$.
 (2) The collection $\{M(\gamma)\}_{\gamma \in \widehat{H}^*}$ is a free family in M_1 .

Proof. The key calculation is that of the free cumulant $\kappa_t(\gamma_{i_1, j_1}^1, \gamma_{i_2, j_2}^2, \dots, \gamma_{i_t, j_t}^t)$ for $\gamma^1, \dots, \gamma^t \in \widehat{H}^*$, which, by Proposition 21 is given by the value of the tangle in Figure 11. Judicious use of various parts of Proposition 3 then shows that this

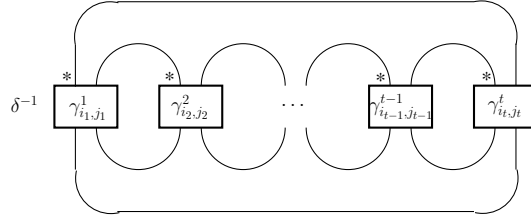

FIGURE 11. $\kappa_t(\gamma_{i_1, j_1}^1, \gamma_{i_2, j_2}^2, \dots, \gamma_{i_t, j_t}^t)$

vanishes unless $\gamma^1 = \gamma^2 = \dots = \gamma^t = \gamma$, say, and $j_1 = i_2, j_2 = i_3, \dots, j_t = i_1$, in which case it equals $(\frac{\delta}{d_\gamma})^{t-1}$. This proves (1) and, combined with Theorem 9 and Lemma 12, yields (2). \square

The final hurdle to be crossed to prove Theorem 19 is the determination of the structure of $M(\gamma)$; before getting to this, we need an elementary fact.

Lemma 23. Suppose that (A, ϕ) is a von Neumann algebraic probability space and $d \in \mathbb{N}$. Assume that

$$(M_d(A), \phi^d) \cong \underset{\alpha_1}{F_1} \oplus \underset{\alpha_2}{F_2} \oplus \dots \oplus \underset{\alpha_k}{F_k},$$

where the F_i are all finite factors and $0 < \alpha_i \leq 1$ with $\sum_i \alpha_i = 1$. Then,

$$(A, \phi) \cong \underset{\alpha_1}{(F_1)_{\frac{1}{d}}} \oplus \underset{\alpha_2}{(F_2)_{\frac{1}{d}}} \oplus \dots \oplus \underset{\alpha_k}{(F_k)_{\frac{1}{d}}}.$$

Proof. Observe first that the direct sum decomposition of the non-commutative probability space $(M_d(A), \phi)$ is unique in the sense that if

$$(M_d(A), \phi^d) \cong \underset{\alpha'_1}{F'_1} \oplus \underset{\alpha'_2}{F'_2} \oplus \dots \oplus \underset{\alpha'_k}{F'_{k'}},$$

is another such decomposition, then $k = k'$ and, after a rearrangement, $F_i \cong F'_i$ and $\alpha_i = \alpha'_i$. To see this, let $\{e_1, \dots, e_k\}$ be the set of minimal central projections of $F_1 \oplus F_2 \oplus \dots \oplus F_k$ and $\{e'_1, \dots, e'_{k'}\}$ be the corresponding set for $F'_1 \oplus F'_2 \oplus \dots \oplus F'_{k'}$. The trace preserving isomorphism between $F_1 \oplus F_2 \oplus \dots \oplus F_k$ and $F'_1 \oplus F'_2 \oplus \dots \oplus F'_{k'}$ induces a bijection between these sets, so that $k = k'$ and we may assume after rearrangement that e_i corresponds to e'_i . Further, the quotient of $F_1 \oplus F_2 \oplus \dots \oplus F_k$ by $1 - e_i$, which is F_i , is isomorphic to the quotient of $F'_1 \oplus F'_2 \oplus \dots \oplus F'_{k'}$ by $1 - e'_i$

which is F'_i . Finally $\alpha_i = \alpha'_i$ since these are the traces of e_i and e'_i respectively and the isomorphism is trace preserving.

Now, since $Z(A) \cong Z(M_d(A))$ which is k -dimensional, it follows that A is isomorphic to a direct sum of k factors. Suppose that $A \cong \tilde{F}_1 \oplus \cdots \oplus \tilde{F}_k$ for factors \tilde{F}_i . Since ϕ^d is tracial and faithful (by the assumed strict positivity of the α_i 's), so is ϕ and so $(A, \phi) \cong \tilde{F}_1 \oplus \cdots \oplus \tilde{F}_k$ for some $0 < \beta_i \leq 1$ and therefore $(M_d(A), \phi^d) \cong M_d(\tilde{F}_1) \oplus \cdots \oplus M_d(\tilde{F}_k)$. By the observation made at the start of this proof, we may assume that $M_d(\tilde{F}_i) \cong F_i$ and that $\beta_i = \alpha_i$. Therefore,

$$(A, \phi) \cong (F_1)_{\frac{1}{d}} \oplus (F_2)_{\frac{1}{d}} \oplus \cdots \oplus (F_k)_{\frac{1}{d}},$$

$\alpha_1 \qquad \alpha_2 \qquad \qquad \alpha_k$

concluding the proof. \square

Proposition 24. *For $\gamma \in \widehat{H}^*$, let $\tau_\gamma = \tau_1|_{M(\gamma)}$. Then*

$$(M(\gamma), \tau_\gamma) \cong \left(\mathbb{C}_{1-\delta^{-1}} \oplus L\mathbb{Z}_{\delta^{-1}} \right)^* d_\gamma^2.$$

Proof. By definition, $M(\gamma)$ is the von Neumann algebraic probability subspace of (M_1, τ_1) generated by the entries of $X(\gamma) \in M_{d_\gamma}(M_1)$. It follows that $M_{d_\gamma}(M(\gamma))$ is the von Neumann algebraic probability subspace of $(M_{d_\gamma}(M_1), \tau_1^{d_\gamma})$ generated by $X(\gamma)$ and $M_{d_\gamma}(\mathbb{C})$.

Notice now that although $\gamma_{kl}^* = S\gamma_{lk}$ (in $P(H)$), we see from the definitions that $\gamma_{kl}^\dagger = \gamma_{lk}$ (in $Gr_1(P)$) and consequently $X(\gamma) \in M_{d_\gamma}(M_1)$ is self-adjoint. By Corollary 22(1), the matrix $X(\gamma)$ is uniformly R -cyclic with determining sequence $\{(\frac{\delta}{d_\gamma})^{t-1}\}_{t \in \mathbb{N}}$; Theorem 11 now implies that $X(\gamma)$ is a free Poisson variable with rate δ^{-1} and jump size δ and so the von Neumann algebraic probability space that it generates is $\mathbb{C}_{1-\delta^{-1}} \oplus L\mathbb{Z}_{\delta^{-1}}$ by Proposition 13.

By Theorem 11 again and Lemma 12, the von Neumann algebraic probability spaces generated by $X(\gamma)$ and $M_{d_\gamma}(\mathbb{C})$ are free in $M_{d_\gamma}(M_1)$ and therefore

$$\begin{aligned} (M_{d_\gamma}(M(\gamma)), \tau_\gamma^{d_\gamma}) &\cong \left(\mathbb{C}_{1-\delta^{-1}} \oplus L\mathbb{Z}_{\delta^{-1}} \right) * M_{d_\gamma}(\mathbb{C}) \\ &\cong \begin{cases} LF(2\delta^{-1} - \delta^{-2} + 1 - d_\gamma^{-2}) & \text{if } \delta^{-1} \geq d_\gamma^{-2} \\ M_{d_\gamma}(\mathbb{C}) \oplus LF(-d_\gamma^{-4} + 1 + d_\gamma^{-2}) & \text{if } \delta^{-1} \leq d_\gamma^{-2} \\ \mathbb{C}_{1-\delta^{-1}d_\gamma^2} & \delta^{-1}d_\gamma^2 \end{cases} \end{aligned}$$

where the last isomorphism appeals to Proposition 17. Now Lemma 23 and Proposition 14 show that

$$(M(\gamma), \tau_\gamma) \cong \begin{cases} LF(2\delta^{-1}d_\gamma^2 - \delta^{-2}d_\gamma^2) & \text{if } \delta^{-1} \geq d_\gamma^{-2} \\ \mathbb{C}_{1-\delta^{-1}d_\gamma^2} \oplus LF(2 - d_\gamma^{-2}) & \text{if } \delta^{-1} \leq d_\gamma^{-2} \\ \delta^{-1}d_\gamma^2 \end{cases}$$

Finally, an application of Corollary 16 with $N = d_\gamma^2$ yields the desired result. \square

We conclude this section with the proof of its main result.

Proof of Theorem 19. Since the family $\{M(\gamma)\}_{\gamma \in \widehat{H^*}}$ is free in M_1 and generates it as a von Neumann algebra,

$$\begin{aligned} M_1 &\cong *_{\gamma \in \widehat{H^*}} M(\gamma) \\ &\cong *_{\gamma \in \widehat{H^*}} \left(\mathbb{C}_{1-\delta^{-1}} \oplus LZ_{\delta^{-1}} \right)^* d_\gamma^2 \\ &\cong \left(\mathbb{C}_{1-\delta^{-1}} \oplus LZ_{\delta^{-1}} \right)^* n \\ &\cong LF(2\sqrt{n} - 1), \end{aligned}$$

where the second isomorphism follows from Proposition 24 and the last isomorphism from Corollary 16. \square

5. DETERMINATION OF M_2

The main result of this section is the identification of M_2 as an interpolated free group factor. The strategy of proof is similar to that of the last section. We determine a pair of subalgebras of $Gr_2(P)$ that are free and generate it and compute the free product of the generated von Neumann algebras to determine M_2 .

Theorem 25. *Let H be a finite dimensional Kac algebra of dimension $n > 1$, $P = P(H)$ be its planar algebra and $M_0 \subseteq M_1 \subseteq \dots$ be the tower of factors associated to P by the GJS-construction. Then, $M_2 \cong LF(\frac{2}{\sqrt{n}} - \frac{2}{n} + 1)$.*

The first step is to determine the structure of $Gr_2(P)$. The graded $*$ -algebra $T(H)$ admits an action by the Kac algebra H defined by $\alpha_a(x^1 \otimes x^2 \otimes \dots \otimes x^t) = a_1 x^1 \otimes \dots \otimes a_t x^t$ for $a \in H$ and $x^1 \otimes x^2 \otimes \dots \otimes x^t \in H^{\otimes t} \subseteq T(H)$ (where we use the notation $a_1 \otimes a_2 \otimes \dots \otimes a_t$ for the iterated coproduct $\Delta^t(a)$). We may form the crossed-product algebra $T(H) \rtimes_\alpha H$ and introduce a grading on it by declaring that $\deg(w \rtimes a) = \deg(w)$ for any $a \in H$ and homogeneous $w \in T(H)$. The natural inclusion $T(H) \subseteq T(H) \rtimes_\alpha H$ is a map of graded $*$ -algebras.

Proposition 26. *The algebras $T(H) \rtimes_\alpha H$ and $Gr_2(P)$ are isomorphic as graded $*$ -algebras by an isomorphism that extends the isomorphism from $T(H)$ to $Gr_1(P)$.*

Proof. Define $\theta : T(H) \rtimes_\alpha H \rightarrow Gr_2(P)$ by letting $\theta(x^1 \otimes x^2 \otimes \dots \otimes x^t \rtimes a)$ be given by the tangle in Figure 12. It is a straightforward consequence of the definitions

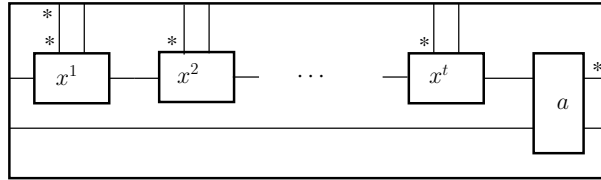

FIGURE 12. Definition of θ

that the restriction of θ to $T(H)$ is the composition of the isomorphism of $T(H)$ with $Gr_1(P)$ and the inclusion of $Gr_1(P)$ into $Gr_2(P)$, while the restriction of θ to the acting H is the natural isomorphism of H with $P_2 \subseteq Gr_2(P)$. Also θ is a linear isomorphism since for each t , the tangle in Figure 12 is just $X = X_{2,2,\dots,2}^{t+2}$ - see Proposition 3(3) - redrawn slightly differently. The crux of the verification of multiplicativity of θ is seen to reduce to the equality asserted in Figure 13, which

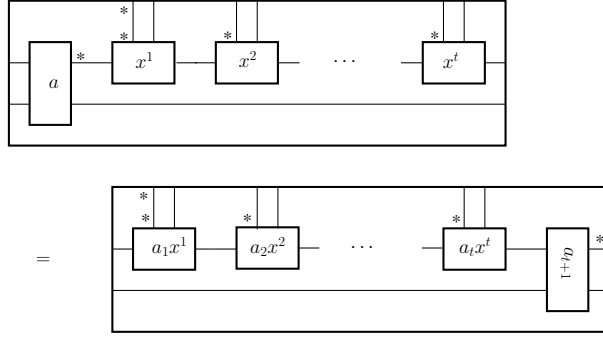

FIGURE 13. Multiplicativity of θ

is a consequence of the relations in $P(H)$. Finally, θ preserves $*$ since it does so on $T(H)$ (by Proposition 20) and on the acting H (clearly!) and is multiplicative. \square

Since the crossed product algebra $T(H) \rtimes_{\alpha} H$ is clearly generated by the two patent copies of H , it follows from Proposition 26 that $Gr_2(P)$ is generated by $P_2 \subseteq Gr_2(P)$ and by the image of $P_2 \subseteq Gr_1(P)$ in $P_3 \subseteq Gr_2(P)$. We will require the following sharpening of this result. Throughout this section we will denote the image of $1 \in P_2 \subseteq Gr_1(P)$ in $P_3 \subseteq Gr_2(P)$ by X and note that pictorially, it is shown in the figure below.



Proposition 27. *The algebra $Gr_2(P)$ is generated by $P_2 \subseteq Gr_2(P)$ and $X \in P_3 \subseteq Gr_2(P)$.*

Proof. From (the sentence immediately following) Proposition 26, it suffices to verify that the image of $P_2 \subseteq Gr_1(P)$ in $P_3 \subseteq Gr_2(P)$ is contained in the subalgebra of $Gr_2(P)$ generated by P_2 and X . However for any $a, b \in P_2 \subseteq Gr_2(P)$, notice that aXb is given by the tangle in Figure 14. Elements of this kind are easily verified to

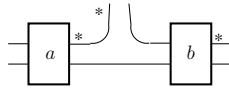

FIGURE 14.

span the whole of P_3 using the depth 2 property of $P(H)$. \square

The main combinatorial fact underlying the determination of M_2 is that the algebra P_2 and the algebra generated by X are free in it, which is what we will establish next. Recall that $\tau_2 = \delta^{-2} Tr_2$ is a normalised trace on $Gr_2(P)$. We will denote the associated free cumulants by $\kappa_*(\dots)$.

Note that $(Gr_1(P), \tau_1)$ is a non-commutative probability subspace of $(Gr_2(P), \tau_2)$ and so the free cumulants of X in $Gr_2(P)$ are the same as those of $1 \in P_2 \subseteq Gr_1(P)$. Since $1 = triv_{11}$ where $triv \in \widehat{H}^*$ is the trivial representation of H^* , it follows -

from Corollary 22 - that $\kappa_t(X, X, \dots, X) = \delta^{t-1}$, or equivalently, that X is free Poisson with rate δ^{-1} and jump size δ .

Proposition 28. *The algebra generated by X and the algebra $P_2 \subseteq Gr_2(P)$ are free in the non-commutative probability space $(Gr_2(P), \tau_2)$.*

Proof. Consider the problem of calculating $Tr_2(X^1 X^2 \dots X^t)$ where each $X^i \in P_2 \cup \{X\}$. Let $D = \{i \in [t] : X^i = X\}$ and $E = \{i \in [t] : X^i \in P_2\}$ so that these are complementary sets in $[t]$.

We illustrate with an example. Suppose $t = 16$ and $D = \{1, 3, 4, 5, 8, 12, 14, 15\}$ so that $E = \{2, 6, 7, 9, 10, 11, 13, 16\}$. The product $\prod_{i=1}^{15} X^i$ in $Gr_2(P)$ is given by the tangle in Figure 15 and its trace is given by the sum over all $\pi \in NC(D)$ of

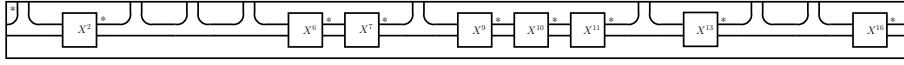

FIGURE 15. $\prod_{i=1}^{15} X^i$

the tangle in Figure 16. We will fix a $\pi \in NC(D)$ and analyse the π -term of the sum.

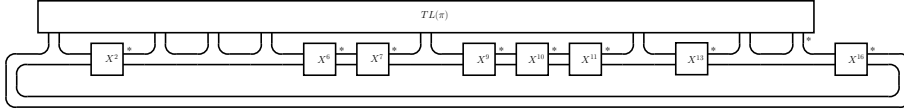

FIGURE 16. The π -term of $Tr_2(\prod_{i=1}^{15} X^i)$

Again, an illustrative example will help. So we consider $\pi = \{\{1, 5\}, \{3, 4\}, \{8, 14, 15\}, \{12\}\}$. Then the π -term is illustrated in Figure 17.

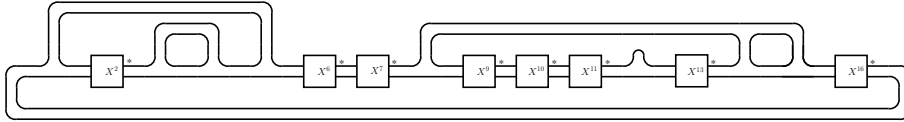

FIGURE 17. The $\{\{1, 5\}, \{3, 4\}, \{8, 14, 15\}, \{12\}\}$ -term of $Tr_2(\prod_{i=1}^{15} X^i)$

Note that the π -term has several floating loops, each contributing a multiplicative factor of δ . Now remove the floating loops and the innermost string connecting all the boxes X^i for $i \in E$ to get Figure 18.

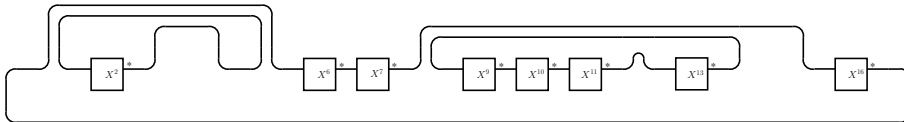

FIGURE 18. Disconnecting Figure 17

There are several connected components, each of which loops some of the boxes X^i , $i \in E$ together and so defines a partition of E . Denote this partition by $\tilde{\pi}$. A

little thought should convince the reader that $\pi \cup \tilde{\pi}$ is a non-crossing partition of $[t]$ and that $\tilde{\pi}$ is coarser than any partition of E with this property.

In our example, $\tilde{\pi} = \{\{2\}, \{6, 7, 16\}, \{9, 10, 11, 13\}\}$. By irreducibility of the planar algebra P , any class, say C , of $\tilde{\pi}$ contributes a multiplicative factor of $\delta\phi(\prod_{c \in C} X^c)$ (where the product is taken with the X^c listed in increasing order) to the π -term. It follows that the π -term evaluates to $\delta^{N(\pi)}\phi_{\tilde{\pi}}(X^e : e \in E)$, where $N(\pi)$ is the number of loops in the figure obtained from Figure 17 by replacing all the $X^i, i \in E$ by $1_2 \in P_2$. This latter figure is shown below.

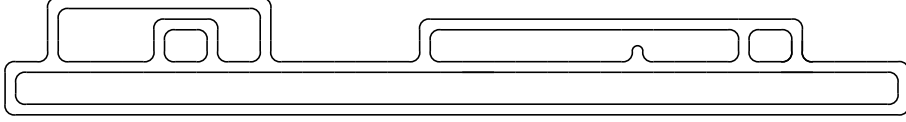

FIGURE 19. Replacing all X^i in Figure 17 by 1_2

Therefore $Tr_2(X^1 X^2 \cdots X^t) = \sum_{\pi \in NC(D)} \delta^{N(\pi)} \phi_{\tilde{\pi}}(X^e : e \in E)$ and hence:

$$\begin{aligned} \tau_2(X^1 X^2 \cdots X^t) &= \sum_{\pi \in NC(D)} \delta^{N(\pi)-2} \phi_{\tilde{\pi}}(X^e : e \in E) \\ &= \sum_{\pi \in NC(D)} \delta^{|D|-|\pi|} \phi_{\tilde{\pi}}(X^e : e \in E) \\ &= \sum_{\pi \in NC(D)} \delta^{|D|-|\pi|} \left(\sum_{\rho \in NC(E), \rho \leq \tilde{\pi}} \kappa_{\rho}(X^e : e \in E) \right) \end{aligned}$$

where the second equality follows from Proposition 29 below, and the third equality is by (3) of Theorem 7.

We now assert that

$$\tau_2(X^1 X^2 \cdots X^t) = \sum_{\lambda \in NC(t)} \tilde{\kappa}_{\lambda}(X^1, \dots, X^t),$$

where $\tilde{\kappa}_{\lambda}$ is the multiplicative extension of $\{\tilde{\kappa}_t : (P_2 \cup \{X\})^t \rightarrow \mathbb{C}\}_{t \in \mathbb{N}}$ defined by

$$\tilde{\kappa}_t(X^1, \dots, X^t) = \begin{cases} \delta^{t-1} & \text{if all } X^i = X \\ \kappa_t(X^1, \dots, X^t) & \text{if all } X^i \in P_2 \\ 0 & \text{otherwise.} \end{cases}$$

To prove this assertion, note that the only $\lambda \in NC(t)$ that contribute to the sum are those of the form $\pi \cup \rho$ where $\pi \in NC(D)$, $\rho \in NC(E)$ and $\rho \leq \tilde{\pi}$, and the corresponding term is exactly $\delta^{|D|-|\pi|} \kappa_{\rho}(X^e : e \in E)$.

But now, Möbius inversion implies that $\tilde{\kappa}_{\pi} = \kappa_{\pi}$ and Theorem 9 then proves the desired freeness of P_2 and the algebra generated by X in $Gr_2(P)$. \square

Proposition 29. *Let $n \in \mathbb{N}$ and $\pi \in NC(n)$. By $L(\pi)$, we will denote the 0-tangle in Figure 20. Let $N(\pi)$ be the number of loops in $L(\pi)$. Then, $N(\pi) - 2 = n - |\pi|$.*

Proof. The proof is an induction on the number of classes $|\pi|$ of π . The basis case $|\pi| = 1$ being easily proved, we consider the case $|\pi| > 1$. Since any non-crossing partition has a class that is an interval, let $C = [k, l]$, $1 \leq k \leq l \leq n$ be such a class of π and let S denote the complement of C in $[n]$. In a ‘neighbourhood’ of C , the

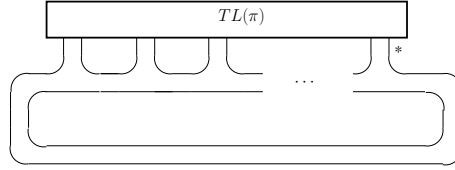
 FIGURE 20. The 0-tangle $L(\pi)$

tangle $L(\pi)$ looks as in Figure 21. After removing the $l - k = |C| - 1$ loops between

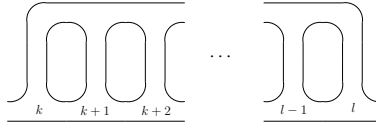
 FIGURE 21. A ‘neighbourhood’ of the class $C = [k, l]$ of π

k and l , it should be clear that what remains is the tangle $L(\pi_S)$ where $\pi_S = \pi|_S$. Hence, $N(\pi_S) = N(\pi) - (|C| - 1)$ while $|\pi_S| = |\pi| - 1$ and $|S| = n - |C|$. The proof is complete by induction. \square

We can now identify the factor M_2 as an interpolated free group factor.

Proof of Theorem 25. By Proposition 27, the algebra $Gr_2(P)$ is generated by P_2 and $X \in P_3$ and so the factor M_2 is generated as a von Neumann algebra by these. Since X is free Poisson with rate δ^{-1} and jump size δ , the von Neumann algebra it generates is isomorphic to $\mathbb{C}_{1-\delta^{-1}} \oplus L\mathbb{Z}_{\delta^{-1}}$. Since this von Neumann algebra and P_2 are free in M_2 by Proposition 28 and Lemma 12, it follows that

$$\begin{aligned} M_2 &\cong \left(\mathbb{C}_{1-\delta^{-1}} \oplus L\mathbb{Z}_{\delta^{-1}} \right) * P_2 \\ &\cong LF\left(2\delta^{-1} - \delta^{-2} + 1 - \frac{1}{n}\right) \\ &\cong LF\left(\frac{2}{\sqrt{n}} - \frac{2}{n} + 1\right), \end{aligned}$$

where the second isomorphism is a consequence of Proposition 18. \square

6. CONCLUSION

Theorem 30. *Let H be a finite dimensional Kac algebra of dimension $n > 1$, $P = P(H)$ be its planar algebra and $M_0 \subseteq M_1 \subseteq \dots$ be the tower of factors associated to P by the GJS-construction. Then, $M_0 \cong LF(2n\sqrt{n} - 2n + 1)$ and $M_1 \cong LF(2\sqrt{n} - 1)$.*

Proof. The statement about M_1 is contained in Theorem 19. For M_0 , since the tower $M_0 \subseteq M_1 \subseteq \dots$ of factors of the GJS-construction is a basic construction tower with index n , the factor $M_2 \cong M_n(M_0)$ or equivalently, $M_0 \cong (M_2)_{\perp_n}$. By Theorem 25 and Proposition 14(2) this is computed to be $LF(2n\sqrt{n} - 2n + 1)$. \square

Remark 31. If $N \subseteq M$ is a finite index subfactor and $\alpha > 0$, then the α -ampliation subfactor $N_\alpha \subseteq M_\alpha$ has the same standard invariant (planar algebra) as $N \subseteq M$. Since all the finite interpolated free group factors $LF(r)$ are ampliations of each other by Proposition 14(2), our main theorem implies that any $LF(r)$ for $1 < r < \infty$ is universal for planar algebras of depth 2, in the sense that given such a planar algebra it is the planar algebra of a subfactor of $LF(r)$.

In the light of the previous remark and the results of [PpaShl2003] on the universality of $LF(\infty)$ it is tempting - and we yield to the temptation - to conjecture the following.

Conjecture 32. Any finite interpolated free group factor $LF(r)$ is universal for finite depth subfactor planar algebras.

ACKNOWLEDGEMENTS

We thank Ken Dykema, Krishna Maddaly, Roland Speicher and Dan Voiculescu for their prompt and helpful responses to our questions in free probability theory.

REFERENCES

- [Dyk1993] K. J. Dykema, *Free products of hyperfinite von Neumann algebras and free dimension*, Duke Mathematical Journal 69 (1993), 97–119.
- [Dyk1994] K. J. Dykema, *Interpolated free group factors*, Pacific Journal of Mathematics 163 (1994), 123–135.
- [VclDykNca1992] D. V. Voiculescu, K. J. Dykema, A. Nica, *Free Random Variables*, CRM Monographs, Vol. 1, AMS (1992).
- [GnnJnsShl2008] A. Guionnet, V. F. R. Jones and D. Shlyakhtenko, *Random matrices, free probability, planar algebras and subfactors*, arXiv:0712.2904v2.
- [Jns1999] V. F. R. Jones, *Planar algebras*, To appear in New Zealand J. Math, arXiv:math/9909027.
- [JnsShlWlk2008] V. F. R. Jones, D. Shlyakhtenko and K. Walker, *An orthogonal approach to the subfactor of a planar algebra*, arXiv:0807.4146.
- [KdyLndSnd2003] Vijay Kodiyalam, Zeph Landau and V. S. Sunder, *The planar algebra associated to a Kac algebra*, Proc.Indian Acad. Sciences 113 (2003) 15–51.
- [KdySnd2004] *On Jones' planar algebras*, J. of Knot Theory and its Ramifications 13, No.2 (2004) 219–248.
- [KdySnd2008] Vijay Kodiyalam and V. S. Sunder, *From subfactor planar algebras to subfactors*, To appear in IJM, arXiv:0807.3704.
- [MrrNmn1943] F. J. Murray and J. von Neumann, *On rings of operators IV*, Annals of Math.(2), 44 (1943) 716–808.
- [NcaSpc2006] A. Nica and R. Speicher, *Lectures on the combinatorics of free probability*, LMS Lecture note series, Vol. 335, CUP (2006).
- [PpaShl2003] S. Popa and D. Shlyakhtenko, *Universal properties of $LF(\infty)$ in subfactor theory*, Acta Math. 191, No. 2 (2003) 225–257.
- [Rdl1994] F. Radulescu, *Random matrices, amalgamated free products and subfactors in free group factors of noninteger index*, Inventiones Mathematicae 115 (1994), 347–389.

THE INSTITUTE OF MATHEMATICAL SCIENCES, TARAMANI, CHENNAI, INDIA 600113
E-mail address: vijay@imsc.res.in

THE INSTITUTE OF MATHEMATICAL SCIENCES, TARAMANI, CHENNAI, INDIA 600113
E-mail address: sunder@imsc.res.in