

A New Closed Loop Speed Control Strategy for a Vector Controlled Three-Phase Induction Motor Drive

Anurag TRIPATHI¹⁾, Arunima DEY¹⁾, Bharti DWIVEDI¹⁾
Bhim SINGH²⁾, Dinesh CHANDRA³⁾

1) Institute of Engineering and Technology, India,

2) IIT Delhi, India,

3) MNNIT, Allahabad, India

Summary: This paper presents a completely mathematical equations based model on control of torque and speed of a three-phase indirect vector controlled VSI fed cage induction motor drive that is controlled through the space vector modulated method. This enables a wide range of acceptability of the model for various values of load and for various types and ratings of induction motors. The uniqueness of the model lies in the fact that the deviations in the torque and speed on sudden application of reference step change in speed values are minimum i.e. when any sudden change in the speed reference is desired, the speed and torque waveforms reveal that the time taken in coming back to their final steady state values is very less and the motor overcomes the perturbation with negligible transients. The same is verified through the simulated results.

Key words:

space vector modulation,
VSI,
induction motor model,
transients,
steady state value.

1. INTRODUCTION

Three phase induction motors occupy an extremely high priority in the industrial applications worldwide. Due to their ruggedness and less maintenance requiring capabilities, they are replacing the conventional dc motor from many areas viz cranes, locomotives etc. Adding to this fact are the continually improving torque and speed control methods of three phase induction motors through semiconductor devices. Vector control method of speed control provides precision and wide range qualities simultaneously. The ever-reducing cost of semiconductor devices is making the whole three-phase induction motor drive, an economically better feasible option for a whole number of control and power applications.

The scalar control is being replaced by vector control developed almost two decades back. The Direct Vector Control uses the devices like Hall sensors and Search Coils for measuring air-gap flux. This method is problematic in the sense that Hall sensors are temperature sensitive and fragile while Search Coils have a drift in the integrator attached to it at very low frequency so an Indirect Vector Control was devised. Indirect method does not rely on air-gap flux measurement and instead uses motor parameters for flux calculation [1–4]. Current controlled VSI is normally used in place of voltage controlled VSI because of the direct control of stator currents (due to fast switching devices and ample dc voltage) than stator voltage which must incorporate additional effects of stator transient inductances [1]. The various PWM techniques utilized in the VSI are analyzed based on [2, 3]. The dynamic modeling of IM is studied from [4]. A literature survey in the area of vector control is carried out. A deep analysis of the dynamic performance of a closed loop Induction motor drive consisting of hysteretic current controlled VSI based on the field-oriented control is done in [5]. It also uses PI controller for speed loop. Any simulation requires the modeling of IM, inverter and controller that is done in [6] using unity power factor converter.

Since quality improvement is the key word in most of the industrial manufacturing, the motors driving the whole mechanisms should address to the required ranges of accuracy, precision and hence control. For an extremely fast torque and speed dynamics, the new electromagnetic torque should accompany the change in the value of load and the new speed should be achieved at minimal time and least steady state error.

2. SCOPE OF THE PAPER

This paper presents a complete control scheme containing controllers, three phase inverter-gating circuitry, three phase inverter and three phase induction motor.

Implementations of various PWM techniques have been a major area of research [7]. Latest of them is space vector modulation technique [8–10]. The basic advantage of SVPWM is that it increases the linear range of operation till a modulation index of 90.7% unlike the conventional sine PWM method having linear range till a modulation index of 78.5%. The concept of operation of linear or non-linear region is based on modulation index that indirectly provides information about the inverter utilization capability. This feature of SVPWM puts on edge over other PWM techniques. Till $M I \leq 0.907$ SVPWM inverter operates in the linear region meaning whereby that the modulation index is directly proportional to the fundamental component of the line side voltage. Beyond $M I = 0.907$ SVPWM inverter stands operating in the non-linear or in other words overmodulation region. This overmodulation region is further divided into two zones. Zone I lies between $0.907 < M I \leq 0.9535$ and zone II lies between $0.9535 < M I \leq 1.0$.

The main aim of any PWM technique is to utilize the inverter to its full capacity that is achieved only with six-step operation. In six-step operation, maximum value of the desired voltage vector is obtained. In SVPWM, the operation

from under modulation to overmodulation finally leads to the above-mentioned fact i.e. to achieve a six-step operation. In the overmodulation range, the fundamental component of the line side voltage and the modulation index are no more proportional. The present paper establishes a linear relationship between them.

The present paper thus also covers the overmodulation region of the space vector modulation (i.e. from 90.7% to 100% till six step).

In the paper, a combination of step waveforms is given as a reference speed that is compared with the actual speed. The resulting speed error is given to a PI controller whose output is then subjected to a matlab function that has one more input that is the actual speed. This Matlab function takes care of the field-weakening region. The logic equations applied in it are as follows:

Where

me_ref = Reference Torque; me_max = Maximum Torque; w = rotor speed.

Function $torq_ref = torq_ref(me_ref, w)$

If ($w < 1.0$ or $w = 1.0$)

$me_max = 1.0;$

end

If ($w > 1.0$)

$me_max = 1.0/w;$

end

The above two logics decide the constant torque region (till the base speed) and field (and hence torque) weakening region beyond base speed,

If ($me_ref > me_max$)

$me_ref = me_max;$

end

$Torq_ref = [me_ref]$

The above logic fixes the value of me_ref at equal to or less than me_max .

The output of the above Matlab function provides the reference value of torque that is necessary to undergo the required changes in speed. This value of reference torque is compared with the actual torque and the torque error is again subjected to a PI controller. A limiter after the controller decides the positive and negative limits of the slip speed; this normalized value of slip speed is added with that of the actual speed to get the normalized value of the synchronous speed of the sector flux vector. The integral of this speed gives the angle (reference vector) at which the stator flux vector lies.

The reference value of stator flux is assumed unity.

A Matlab function having ten inputs is next provided.

The inputs are:

- Reference stator flux (of unity value)
- Actual stator flux (alpha component)
- Actual stator flux (Beta component)
- Actual stator current (alpha component)
- Actual stator current (Beta component)
- Synchronous speed W_s
- T_s (Sampling interval)
- Reference angle of the stator flux
- Actual speed W and
- Reference torque value.

Taking the basis of error flux between actual and reference stator flux values, the switching times of the space vector modulation are calculated as;

$$\tau_a = (\Delta\Psi_s / \pi/3) * \{ \sin(\pi/3 - \alpha_{ref}) / \sin \pi/3 \} \quad (1a)$$

$$\tau_b = (\Delta\Psi_s / \pi/3) * \{ \sin \alpha_{ref} / \sin \pi/3 \} \quad (1b)$$

$$\tau_0 = T_s - (\tau_a + \tau_b) \quad (1c)$$

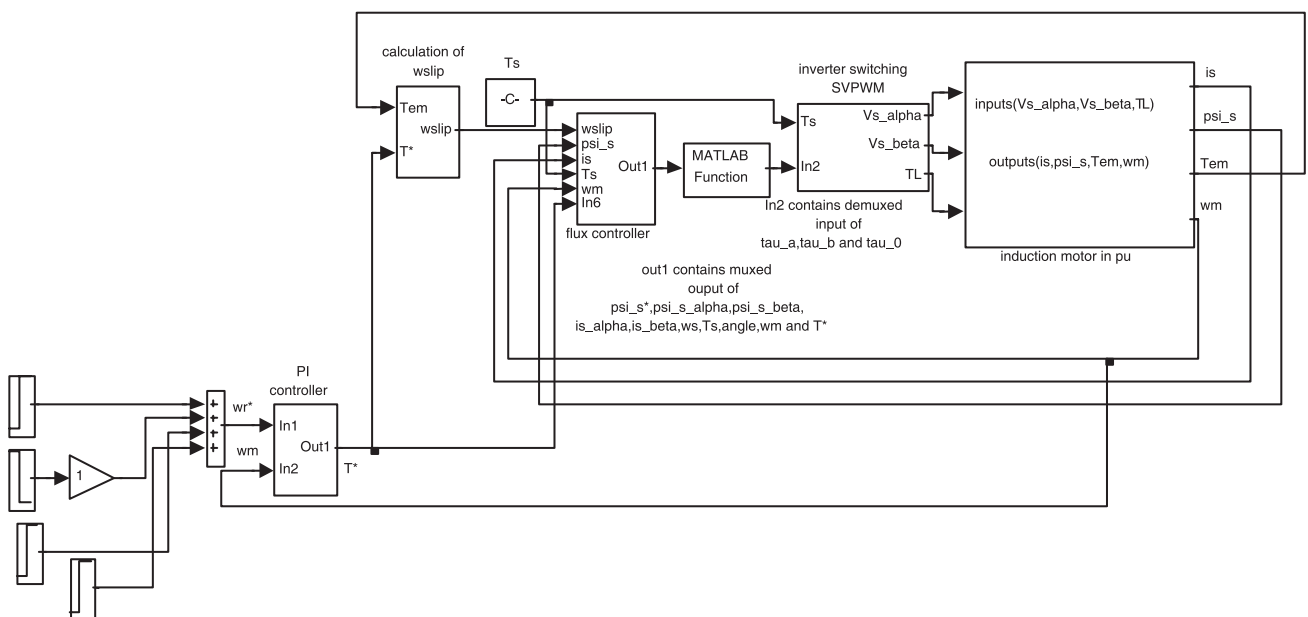

Fig. 1. complete model of vector speed control of IM drive

3. MATHEMATICAL MODEL OF THE INDUCTION MACHINE

The three-phase induction motor is modeled in Figure 1 using the three phase to two phase ($\alpha - \beta$) transformation theory in the stationary reference frame of the machine variables following equations are made use of:

$$V_s = I_s * R_s + d\lambda_s/dt \quad (2)$$

$$0 = I_r * R_r + d\lambda_r/dt - j * W_0 * \lambda_r \quad (3)$$

$$\lambda_s = L_s * I_s + L_m * I_r \quad (4)$$

$$\lambda_r = L_m * I_s + L_r * I_r \quad (5)$$

Taking $i_{s\alpha}$, $i_{s\beta}$, $\lambda_{s\alpha}$, $\lambda_{s\beta}$ as state variables and solving the above four equations we get the required mathematical model of three phase induction motor with torque, speed, actual stator flux (real and imaginary parts) and stator currents as the outputs.

The torque expression is:

$$T = L_m / L_r (I_{s\beta} \lambda_{s\alpha} - \lambda_{s\beta} I_{s\alpha}) \quad (6)$$

The reference speed is actually a combination of four step signals applied at appropriate intervals to check the performance of motor at the time of i) Starting (ii) Running at normal (linear) modulation range and (iii) running of the overmodulation range into six step and beyond (i.e. field weakening regions). Thus the above Matlab function gives us the three switching times τ_a , τ_b , and τ_o in a sector and the sector number where the flux error vector lies. These four along with the sampling period T_s and the sector number are given in the block 'switching' which gives the (normalized) values of $V_{s\alpha}$ and $V_{s\beta}$ to be given as inputs to the three-phase induction motor model. Also a third input namely the load torque is given to the motor model.

4. RESULTS AND DISCUSSION

Figure 2 shows the flux producing that is the direct component of the stator current. It shows how the actual

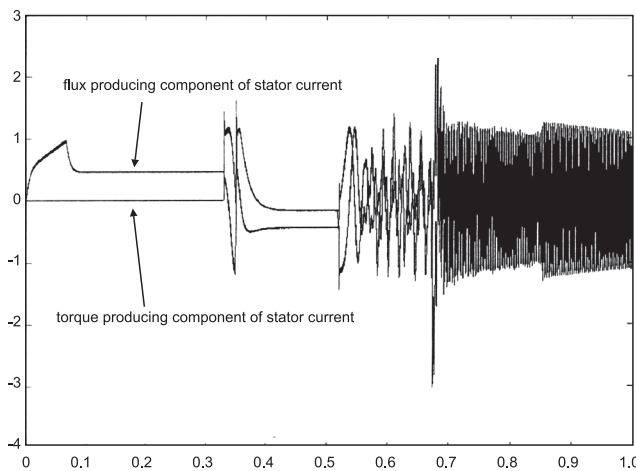
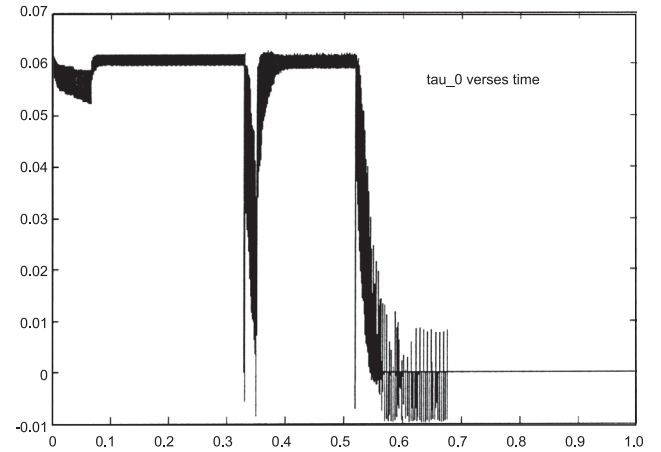
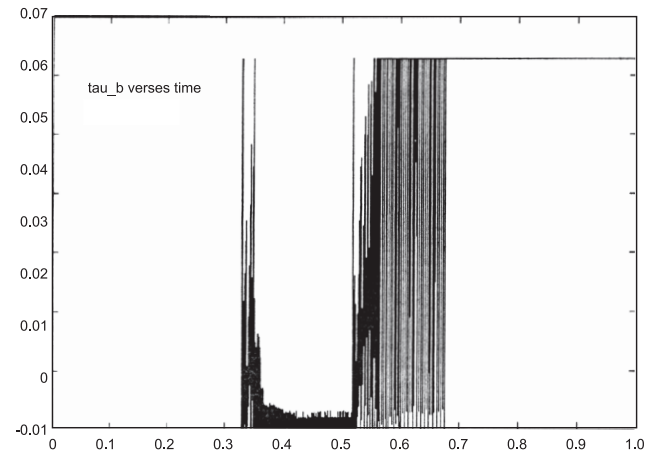

Fig. 2. flux producing (direct) component of the stator current

flux traces the unity reference flux value and later the flux settles down to a value of 0.9. At $t = 0.33$ seconds when a step signal (as the reference speed of magnitude 1pu) is applied, the flux producing current component takes a dip (increase in speed needs a reduction in flux). Figure 2 is the quadrature component of the stator current, which is responsible for the production of torque. As can be seen, this component shoots up at the arrival of the speed reference at $t = 0.33$ seconds to provide the requisite torque. Figure 3 shows the variations in the values of the a) Zero voltage switching time i.e. τ_0 ,



a)



b)

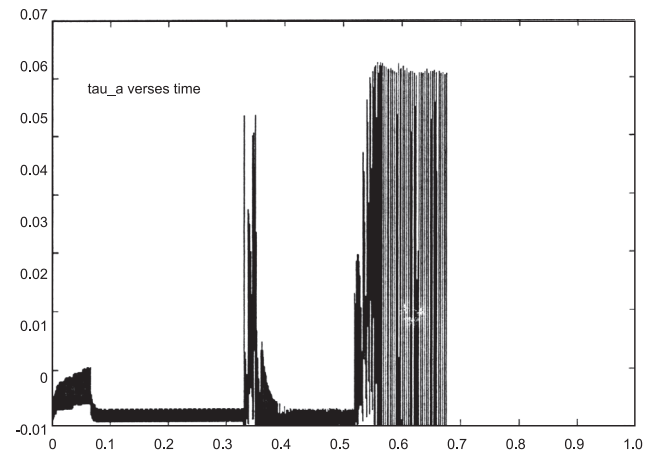

c)

Fig. 3. Waveforms of the three Switching times τ_0 , τ_b and τ_a respectively

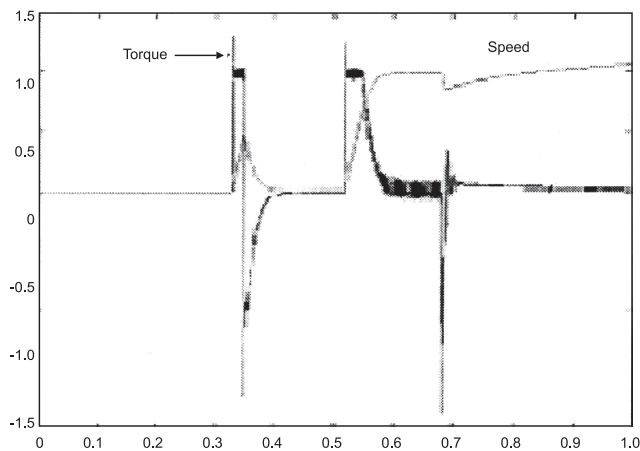

Fig. 4 Torque and speed v/s time for the Drive

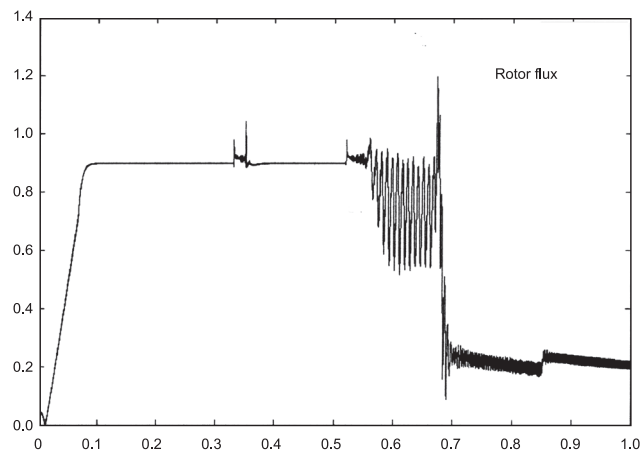

Fig. 7 Rotor flux v/s time

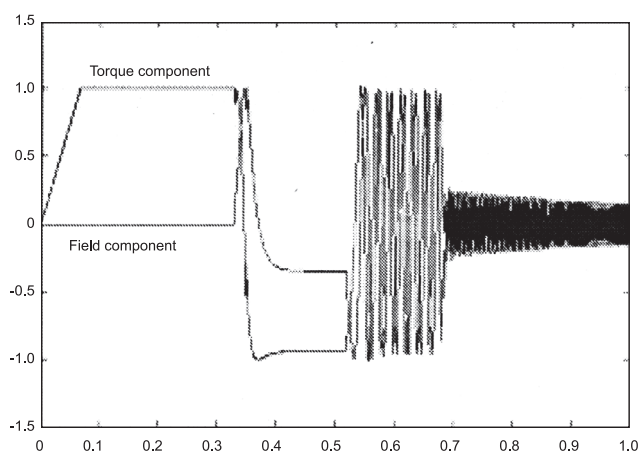

Fig. 5. Quadrature (torque producing) and Direct (field producing) components of the stator current

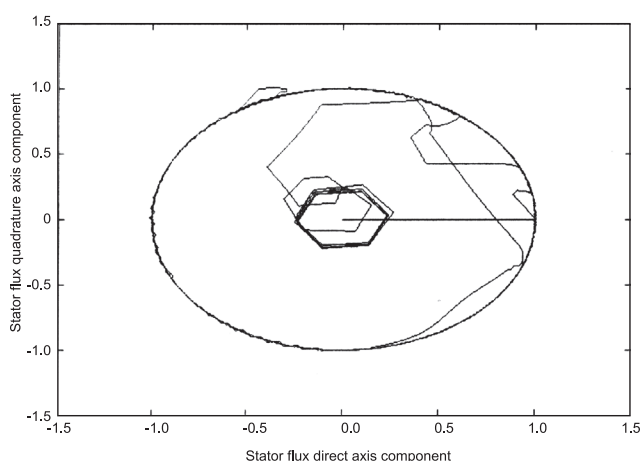

Fig. 6. Locus of Stator flux direct axis component v/s stator flux quadrature axis component

b) Active voltage switching times τ_b and τ_a within a sector of the space vector pulse width modulation. It can be seen that as soon as the speed reference is applied at $t = 0.33$ seconds, the τ_0 value drops and τ_b and τ_a values rise in order to provide the requisite demanded voltage vector in a given sector. Figure 4 shows the variations in the values of torque and speed. It can be seen that as soon as the speed reference occurs at $t = 0.33$ seconds the torque value

starts increasing and it reaches its final value in around 10 milliseconds which is the contribution of this paper. Also the speed too takes a very minimal time to attain the desired reference value but soon at $t = 0.35$ seconds another step is applied of the value minus unity (thus a pulse of 0.02 seconds duration is applied as a reference speed signal). The variations in the values of the actual torque, speed, currents, and rotor flux are shown for the above reference speed pulsed signal.

At $t = 0.52$ seconds, a reference speed signal equal to 0.98 pu is applied which corresponds to the over modulation II region where only active voltage vectors are switched. The τ_0 becomes negative according to its expression that is revealed in the Figures 3a–3c. Finally, a step of value 1.7 pu is applied at $t = 0.67$ seconds to check the feasibility of the model in the field weakening regions (i.e. at higher than 1 pu regions).

This causes a sudden reduction in the value of flux as shown in the Figure 5. This reduction in flux is accompanied by a sudden reduction in the magnitude of the electromagnetic torque due to which the speed starts reducing to start with. Soon the flux value settles down and the torque recovers to a low yet steady value and the speed again starts increasing. At $t = 0.85$ seconds, the speed becomes 1 pu and this is the point at which the six step operation of the three phase inverter starts taking place. Now onwards the active voltage vectors have to be continuously applied in a particular sampling interval, so τ_a and τ_b attain particular values of 0.0628 which is equal to $2 \cdot \pi \cdot f \cdot T_s$ for $f = 50$ hz and $T_s = 0.0002$ seconds. The V/f ratio cannot be kept constant now because voltage cannot be increased and the speed demand equivalent to 170% (1.7 p.u) of the rated speed necessitates the increase of frequency.

5. CONCLUSION

The model presented in this paper is unique in the following terms:

- Most of the research work regarding the control of torque and speed of three phase induction motors can provide linear control up to a modulation index of 78.5% (for sine PWM) and 90.7% (for Space Vector PWM). This paper enables speeds beyond 0.907 pu to the overmodulation

region (0.98 pu) and even in the six-step region (1.7 pu) where the field weakening range sets in.

- The rise times and the settling times provided by the model to changing values of torque and speed are quite less as compared to the ones reported.
- The model also takes care of the transient stability with no overshoot in speed and manageably less overshoot in torque values.
- The ripples in the values of torque are very less and those in speed are virtually non-existent.

REFERENCES

1. Ong C.M.: *Dynamic Simulation of Electric Machinery*. Prentice Hall, New Jersey, 1998.
2. Bose B.K.: *Modern Power Electronics and AC Drives*. Prentice Hall of India, New Delhi, 2002.
3. Krishnan R.: *Electric motor drives: Modeling, analysis and control*. Prentice Hall of India, New Delhi, 2001.
4. Mohan N.: *Advanced Electric Drives- Analysis, Control and modeling using Simulink*. MNPERS, 2002.
5. Singh B.N., Singh B. and Singh B.P.: *Performance Analysis of a Closed Loop Field Oriented Cage Induction Motor Drive*. Electric Power Systems Research, 29 (1994), pp. 69–81.
6. Singh B.N., Singh B. and Singh B.P. *Modeling of a Vector Controlled AC Servo Drive fed from Unity Power Factor Converter*. EPSR, 1995.
7. Holtz J.: *Pulsewidth Modulation — A Survey*. IEEE Trans. Industrial Electronics, Vol. 39, No.5, Dec 1992, pp. 410–420.
8. Bowes S.R. and Lai Y.S.: *The Relationship between Space-Vector Modulation and Regular-Sampled PWM*. IEEE Trans. Industrial Electronics, Vol. 44, No.5 1997, pp. 670–679.
9. Bowes S.R. and Holliday D.: *Novel Harmonic Elimination PWM Control Strategies for Three-Phase PWM Inverters using Space-Vector Techniques*. IEE Proc.-Electr. Power Appl., Vol. 146, No. 5, 1999, pp. 495–514.
10. Zhou K. and Wang D.: *Relationship between Space-Vector Modulation and Three-Phase Carrier-Based PWM: A Comprehensive Analysis*. IEEE Trans. Industrial Electronics, Vol. 49, No.1, Feb 2002, pp. 186–195.

The present paper has not been presented in any conference



Mr Anurag Tripathi

is senior Lecturer in the Electrical Engineering Department of the Institute of Engineering and Technology, Sitapur Road, Lucknow, U.P., India. He is pursuing his PhD in the area of Electric Drives from U.P.T.University, Lucknow.

Phone: +919415425768.

Email: shuklakavita@Rediffmail.com



Miss. Arunima Dey

is Lecturer in the Electrical Engineering Department of the Institute of Engineering and Technology, Sitapur Road, Lucknow, U.P., India. She is an associate member of Institution of Engineers (India). She is pursuing her PhD in the area of Electric Drives from U.P.T.University, Lucknow.

E-mail: arunimadey@rediffmail.com.



Dr Bharti Dwivedi

is professor & head in the Electrical Engineering Department of the Institute of Engineering and Technology, Sitapur Road, Lucknow, U.P., India. Her area of interest includes ANN, Power Quality Improvement.

Phone: 915224048747.

E-mail: bharti_dwivedi@yahoo.co.in.



Dr Bhim Singh

is professor in the Electrical Engineering Department in I I T Delhi. His fields of interest include power electronics, electrical machines, electric drives, power quality, FACTS (flexible ac transmission systems), HVDC (High voltage direct current) transmission systems. Prof. Singh is a Fellow of the Indian National Academy of Engineering (FINAE), Institution of Engineers (India) (FIE), and Institution of Electronics and

Telecommunication Engineers (FIETE) and a Life Member of the Indian Society for Technical Education (ISTE), System Society of India (SSI), and National Institution of Quality And Reliability (NIQR) and Senior Member of Institute of Electrical and Electronics Engineers (IEEE).

Phone: +911126591045.

E-mail: bsingh@ee.iitd.ac.in.



Dr Dinesh Chandra

is professor in the Electrical Engineering Department in MNNIT, Allahabad. His subjects of interest include Control Systems, Model Reduction Techniques, Optimization theory & Fuzzy Systems. He is a Life Member of the Indian Society for Technical Education (ISTE).

Mailing Address:

A-09, Staff Colony, MNNIT, Allahabad.

Phone: +91-532-540527,91-532-2271709.

E-mail: dinuchandra@rediffmail.com

